

## SPOTLIGHTS

### Specifications

Housing material	Aluminium   Stainless steel
Surface finish	Anodized, color on request
Cover material	Acrylic   Glass
Weight	0.4 kg
LED type	Cree XP-G3
LED lifetime	L90B10 @ 80.000 hours
CCT	3000K   4000K or on request
CRI	≥ 80
Voltage	230 V
Cable	1500mm, 3x1,5mm <sup>2</sup>
Dimmable	None   DALI
Future proof	Yes
Net efficiency	130 Lumen/Watt
Light output	675 lm
Lens	45°

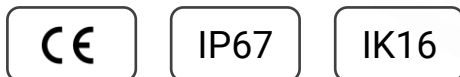

**i** These specifications can be customized on request, please contact us for more information

### Dimensions

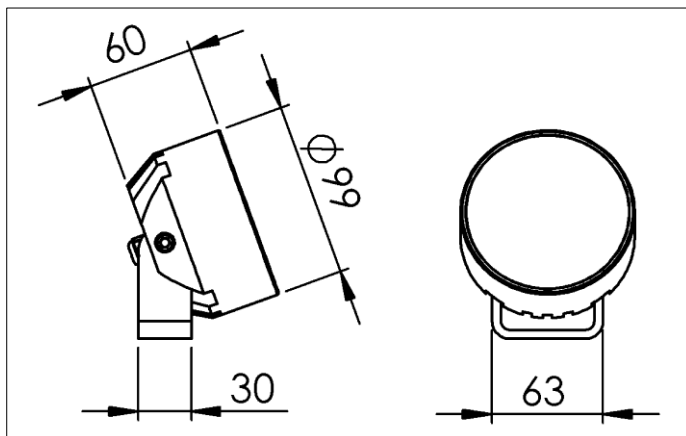

### Light characteristics

