

SPOTLIGHTS

Specifications

Housing material	Aluminum
Surface finish	Anodized, color on request
Cover material	Acrylic Glass
LED type	Cree XP-G3
Lifetime fixture	30 years
Voltage	230 V
CRI	≥ 80
Dimmable	None DALI 1-10V
Future proof	Yes
Net efficiency	150 Lumen/Watt
Max light output	1350 lm
Lens	25°
Weight	0.5 kg

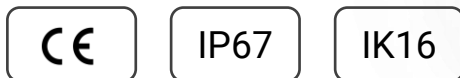

i These specifications can be customized on request, please contact us for more information

Dimensions

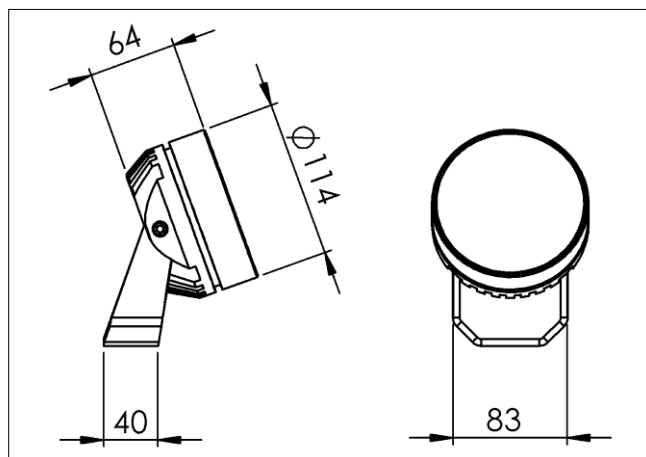

Light characteristics

